

# 1SS181

ROHS

Plastic-Encapsulate Switching Diode

## Features

- ◆ Low Forward Voltage
- ◆ Fast Reverse Recovery Time

## Mechanical Data

- ◆ Case: SOT-23
- ◆ Molding Compound Flammability Rating : UL 94V-O
- ◆ Quantity Per Reel : 3,000pcs
- ◆ Device Marking: A3

## Mechanical Characteristics

Parameter	Symbol	Value	Units
Repetitive Peak Reverse Voltage	VRRM	80	V
Reverse Voltage	VR	80	V
Forward Continuous Current	IFM	0.3	A
Average Rectified Output Current	IO	0.1	A
Non-Repetitive Peak Forward Surge Current @t=8.3ms	IFSM	2.0	A
Power Dissipation	PD	0.15	W
Thermal Resistance Junction to Ambient	R <sub>θJA</sub>	833	°C/W
Junction Temperature Range	TJ	-55~+150	°C
Storage Temperature Range	Tstg	-55~+150	°C



www.unsemi.com.tw

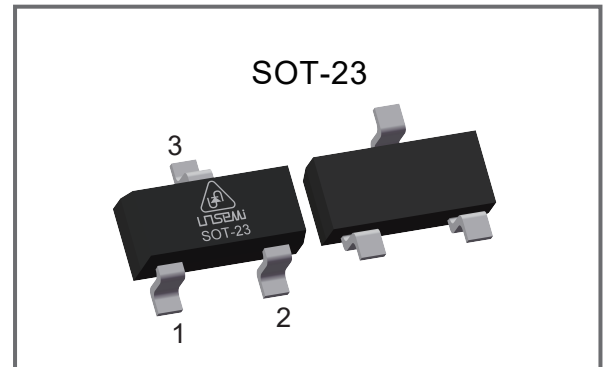

## Functional Diagram

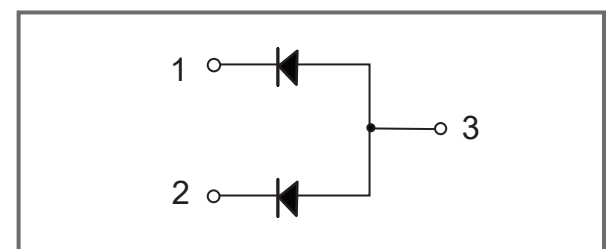

**Electrical Characteristics (Ratings at 25°C ambient temperature unless otherwise specified)**

Parameter	Symbol	Test Conditions	Value			Units
			Min.	Typ.	Max.	
Reverse Current	I <sub>R</sub>	V <sub>R</sub> =30V	-	-	0.1	μA
		V <sub>R</sub> =80V	-	-	0.5	μA
Forward Voltage	V <sub>F</sub>	I <sub>F</sub> =1mA	-	0.61	-	V
		I <sub>F</sub> =10mA	-	0.74	-	V
		I <sub>F</sub> =100mA	-	0.92	1.2	V
Capacitance Between Terminals	C <sub>T</sub>	V <sub>R</sub> =0V, f=1MHz	-	2.2	4.0	pF
Reverse Recovery Time	t <sub>rr</sub>	I <sub>F</sub> =I <sub>R</sub> =10mA, I <sub>rr</sub> =0.1X I <sub>R</sub>	-	1.6	4.0	nS

Electrical Characteristics Curves

Fig.1 Forward Characteristics

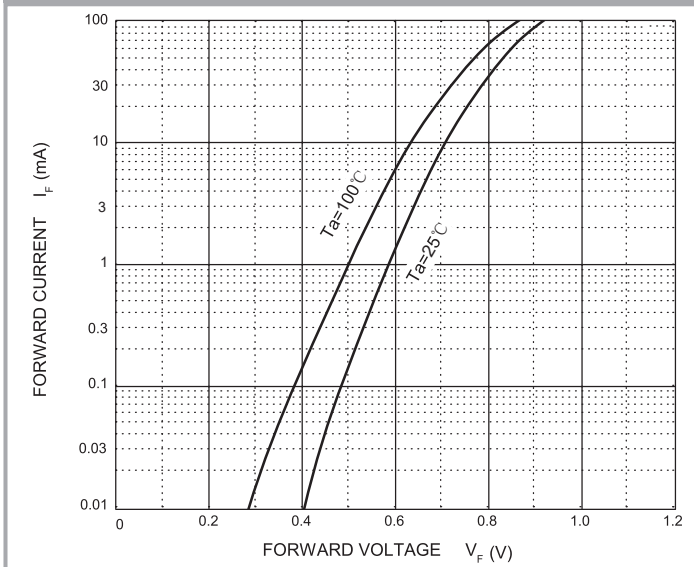

Fig. 2 Reverse Characteristics

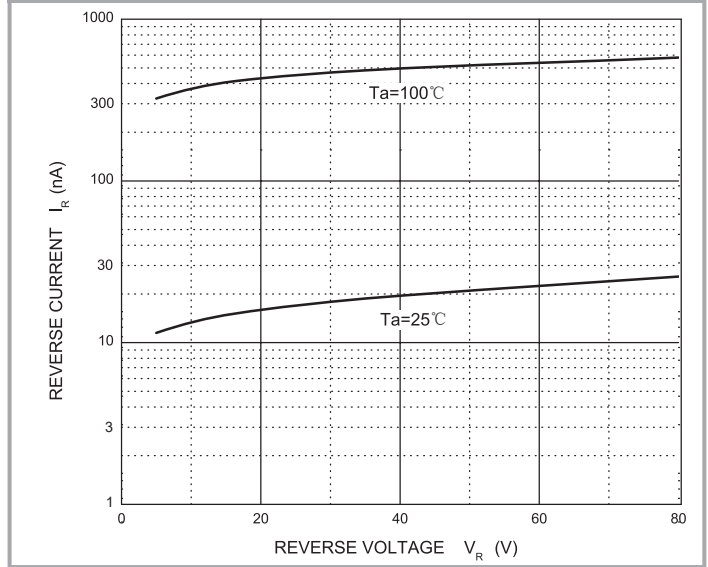

Fig.3 Capacitance Characteristics

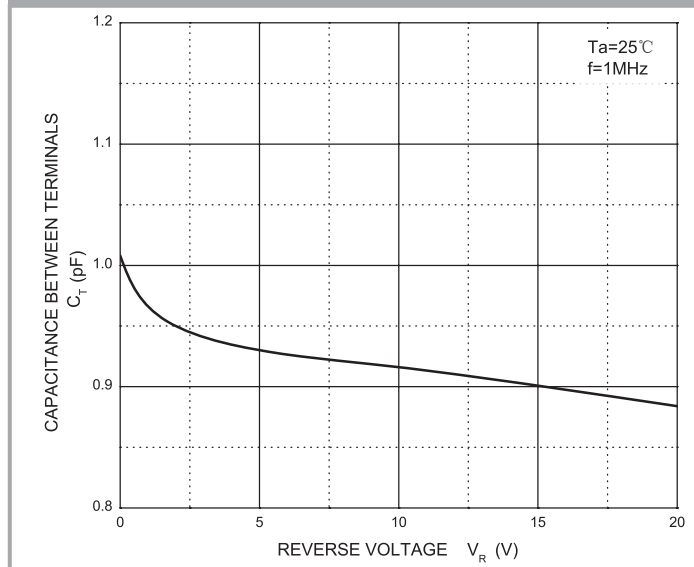
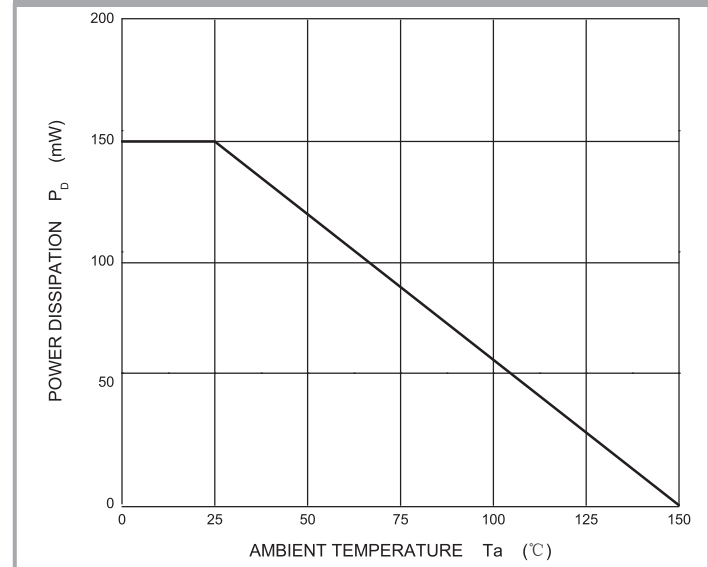
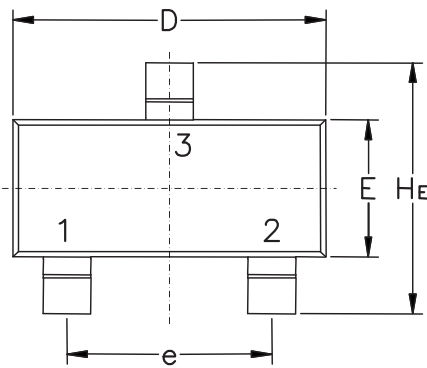

Fig. 4 Power Derating Curve



Package Outline & Dimensions



Symbol	Millimeters			Inches		
	Min.	Nom.	Max.	Min.	Nom.	Max.
A	0.89	1.00	1.11	0.035	0.040	0.044
A1	0.01	0.06	0.10	0.001	0.002	0.004
b	0.37	0.44	0.50	0.015	0.018	0.020
C	0.09	0.13	0.18	0.003	0.005	0.007
D	2.80	2.90	3.04	0.110	0.114	0.120
E	1.20	1.30	1.40	0.047	0.051	0.055
e	1.78	1.90	2.04	0.070	0.075	0.081
L	0.35	0.54	0.69	0.014	0.021	0.029
HE	2.10	2.40	2.64	0.083	0.094	0.104

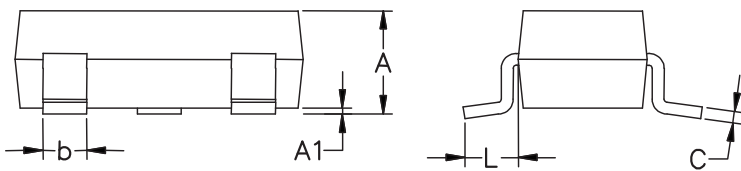

Soldering Footprint

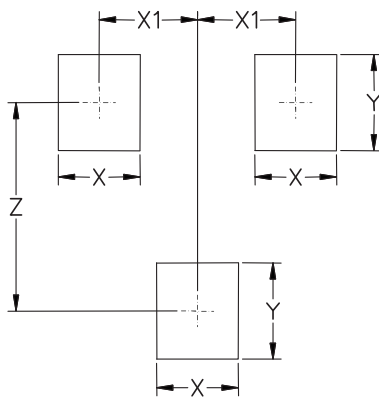

Symbol	Millimeters	Inches
X	0.80	0.031
X1	0.96	0.037
Y	0.90	0.035
Z	2.00	0.079

## Disclaimer

UNSEMI RESERVES THE RIGHT TO MAKE CHANGE ON OUR PRODUCTS , PRODUCTS SPECIFICATION AND DATA WITHOUT NOTICE TO IMPROVE RELIABILITY, FUNCTION OR DESIGN OR OTHERWISE.

UN SEMICONDUCTOR LIMITED its affiliates, agents, and employees, and all persons acting on its or their behalf (collectively, "UNSEMI") does not give any representations or warranties for any errors, inaccuracies or incompleteness contained in any datasheet or in any other disclosure relating to any product.

In no event shall UNSEMI be liable for any indirect, incidental, punitive, special or consequential damages (including any and all implied warranties, warranties of fitness for particular purpose, non-infringement and merchantability.) whether or not such damages are based on tort (including negligence), warranty, breach of contract or any other legal theory.

Statements regarding the suitability of products for certain types of applications are based on UNSEMI knowledge of typical requirements that are often placed on UNSEMI products in generic applications. Such statements are not binding, statements about the suitability of products for a particular application. It is the customer's responsibility to validate that a particular product with the properties described in the product specification is suitable for use in a particular application. Parameters provided in datasheets or specifications may vary in different applications and performance may vary over time. All operating parameters, including typical parameters, must be validated for each customer application by the customer's technical experts. Product specifications do not expand or otherwise modify UNSEMI's terms and conditions of purchase, including but not limited to the warranty expressed therein.

Unless otherwise agreed in writing, UNSEMI product is not designed, authorized or warranted to be suitable for use in medical life-saving, or life-sustaining application , nor in applications where failure or malfunction of a UNSEMI product can reasonably be expected to result in personal injury, death or severe property or environmental damage. UNSEMI and its suppliers accept no liability for inclusion or use of UNSEMI products in such equipment or applications and therefore such inclusion and/or use is at the customer's own risk.

All referenced brands, product names, service names and trademarks are the property of their respective owners.